

ZWO ASI Mount 3

User Manual



Table of Contents

Preface

Tips

Packing List

1. Product Introduction

2. Performance Parameters

3. How to Use

3.1 Introduction to the AM3

3.2 Introduction to the hand controller

3.3 Mounting the AM3

3.3.1 Mount installation

3.3.2 Hand controller connection

3.3.3 ASI Mount App connection

3.3.4 Optional accessory installation

3.3.4.1 Pier extension installation (optional)

3.3.4.2 Counterweight installation (optional)

3.3.4.3 The ASIAIR installation (optional)

3.4 Use of AM3

3.4.1 How to adjust the latitude angle from gear 1 to gear 2

3.4.2 How to adjust the azimuth scale

3.4.3 How to switch from the equatorial mode to the alt-azimuth mode

3.4.4 How to control the mount via PC

3.4.5 How to control the mount via ASI Mount App

3.4.6 How to control the mount via ASIAIR

4 Structural Dimensions

5 After Sales

6 Warranty

Preface

Thank you for purchasing the ZWO ASI Mount 3 Strain Wave Gear Mount (AM3 hereafter).

After years of research, ZWO developed strain wave gears to meet the astrophotography needs of the mount for low periodic error, stable transmission, and high torque output. Each mount has a specific Periodic Error Test Report that can guarantee the mount's performance. In addition, the belt drives are adopted in both axes to achieve 300:1 reduction, which benefits high-precision control. To make the AM3, ZWO uses updated technology, computer integrated manufacturing system, and modern industrial design concepts. The AM3 does not unthinkingly pursue a lightweight design. Still, it focuses more importantly on stability and durability during use, which brings the AM3 a balance between lightweight design and stability in use.

Therefore, the AM3, as a strain wave gear German equatorial mount with a lightweight design and a descent load capacity, can meet the requirements of most carry-on astrophotography setups.

The purpose of this manual is to introduce the use of the AM3 to users in the form of text descriptions and illustrations and to remind users of possible improper operations or dangerous situations. Please make sure to read this manual carefully before using the AM3 and follow the instructions in this manual carefully. Otherwise, the user takes responsibility for any equipment damage and personal injury caused by improper operation. Both software and hardware of the ZWO AM3 strain wave gear mount are developed and designed with independent intellectual property rights perfectly compatible with the ASIAIR, ASCOM, and INDI protocols.

Tips

This manual can guide the user to use the AM3 safely and efficiently. Please read the following tips carefully before using and follow the instructions in this manual during actual use.

1. When using the AM3, please do not directly image or observe the sun with the naked eye through telescopes or finder scopes without proper filtering. Doing so may cause permanent and irreversible damage to the observer's eyes or the equipment. For solar observing and imaging, always use proper solar filters.
2. Please choose proper tripods and counterweights (or not) according to the size and weight of your telescope. The center of gravity of your telescope may wobble out of the tripod legs and cause the whole device to tip over in specific scenarios without a counterweight bar and Counterweight installed. Please test the center of gravity of the telescope in all directions in advance to avoid equipment damage or personal injuries.
3. If the mount is not booted from the Home Position, please set it at the Home Position before you do other operations. After you complete the current shooting section, please also return it to the Home Position and then power down the mount. Failure to do so will probably lead to the inaccuracy of the Home Position and the GOTO function for your next use, which might bring equipment damage or personal injuries going further.
4. Please stop unsupervised children from using or touching the mount, which will help avoid accidental rollovers or personal injuries. In addition, small parts are included with this mount which may also cause suffocation or other damage to children.
5. Do not put the mount in places with high humidity or alkali salt. Doing so may cause corrosion of the components, malfunction of the mount, reduction of the accuracy of the mount slewing and tracking, short circuits, or permanent damages.
6. Do not use corrosive solutions to wipe or clean the mount, which may corrode the surface oxide layer and damage the mount. Also, exposing the mount to the sun for extended periods may cause the appearance of the oxide layer to discolor.
7. Do not attempt to disassemble the mount without ZWO certificates. Inappropriate disassembling may damage the mount, reduce the accuracy of the mount slewing and tracking or even cause personal injuries to the user.
8. The AM3 is a sophisticated instrument. Please handle it carefully to avoid damage to the mount or reduce the accuracy of the mount slewing and tracking.
9. We recommend the operational temperature of the AM3 between -15°C and 40°C . Please do not use the mount outside this temperature range. Doing so may cause the equipment to fail to operate normally and may cause equipment damage.

Packing List

1. Case x1
2. AM3 x1
3. 2-meter USB-B to USB-A 2.0 cable x1
4. AM3 Periodic Error Report x1
5. Quick Guide Brochure x1
6. Hand Controller x1
7. 2-meter Hand Controller Cable x1
8. M6 Allen key x1
9. M4 Allen key x1

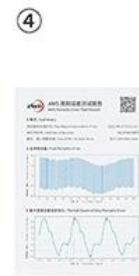

1. Product Introduction

As the second strain wave gear mount released by ZWO, the AM3 integrates lightweight, high precision, modern intelligence, and high performance. It meets the needs of astrophotography and the market trend of portability prior, making it a revolutionary outbreak product compared to traditional worm gear mounts.

The mount's features are as follows:

1. High precision: The AM3 is equipped with a specifically designed strain wave gear reducer for astrophotography which brings high-precision control and stable large torque output. The periodic errors of each mount are measured and limited to ± 15 arcseconds.
2. High load: With a self weight of just 3.9kg, AM3 bears a large load capacity of 8kg. If a 5kg counterweight is added, it even can carry 13kg.
3. Control system with proprietary intellectual property: The software and hardware control system with completely independent intellectual property rights are maintained and upgraded by a professional team to ensure the stability of the whole system.
4. Dual mode: The AM3 has two modes - equatorial mode and alt-azimuth mode, suitable for visual use and astrophotography.
5. No restrictions on areas of use: The AM3 is designed with a latitude angle of 0-90 degrees and can also be used near the equator or the polar regions.
6. Smartphone App control: Through Wi-Fi and Bluetooth wireless connection, you can access the basic and important functions, such as Tonight's Best, target GOTO, and real-time star database on the mobile app ASI Mount - no need to connect to a computer! And you can even upgrade the firmware of the mount and hand controller on the APP.

Other key points:

1. Fully-sealed-structure design: Prevents the strain wave gears from rusting, dust, and dew, keeping the gears working precisely and stably for a long time.
2. Convenient Home Position design: The mount can return to the mechanical Home Position quickly and easily at any mount position.
3. Power-off brake: The power-off attached to the RA axis prevents the telescope and equipment from falling during a power failure.
4. Multi-connection methods: The mount can be controlled by mobile Apps (ASI Mount and ASIAIR), ASCOM software or INDI protocol on PCs.

2. Performance Parameters

Items	Description
Mount type	German Equatorial Mount
Mount mode	Equatorial/Alt-Azimuth
Drive	Strain Wave Gear + synchronous belt (300:1 reduction ratio)
Periodic error	<±15"
PE duration	288s
Drive (R.A.)	Stepper motor + synchronous belt + 14 type 100 reduction ratio strain wave gear + brake
Drive (DEC)	Stepper motor + synchronous belt + 14 type 100 reduction ratio strain wave gear
Payload	8kg (without counterweight) / 13kg (with counterweight) @20cm
Mount weight	3.9 kg
Latitude adjustment range	0°-90°
Azimuth adjustment range	±6°
Dovetail saddle	Losmandy & Vixen
Interface thread for counterweight bar	M12x1.75 coarse teeth
Resolution	0.17"
Max slew speed	6°/S
Slew speed	0.5x, 1x, 2x, 4x, 8x, 20x, 60x, 720x, 1440x
Power port	DC D5.5x2.1mm (12V, no less than 3A)
Power consumption	12V/0.4A (Standby) 12V/0.6A (Tracking) 12V/1.7A (GOTO)
Auto Guide port	ST4
Communication port	USB/Wi-Fi/BT
Zero position	Mechanical
Operating temperature	-15°C-40°C
Power-off brake	R.A. axis

3. How to Use

3.1 Introduction to the AM3



- ① **Finder shoe mounting holes:** Can be used to install the ZWO finder bracket, which can mount the ASI AIR.
- ② **Power button:** Turn the power on and off.
- ③ **Counterweight shaft mounting house:** Unscrew the cover to connect the ZWO counterweight shaft (optional). The thread is M12×1.75, coarse.
- ④ **Hex screws for shifting latitude gear:** A pair of screws are on both sides of the mount. Loosen them with the M6 Allen key, then adjust your desired latitude angle. Don't forget to tighten them after adjustment.
- ⑤ **Latitude lock knobs:** Loosen the knob to adjust the latitude. Don't forget to tighten it after adjustment.
- ⑥ **Latitude fine adjustment knob:** Rotate it clockwise to get the mount up in latitude and counterclockwise to get it down in latitude.
- ⑦ **Azimuth fine adjustment knobs:** Rotate the knobs in opposite directions to each other to adjust the azimuth base. It is best to keep the knobs slightly done up to prevent wobble.



⑧ **Dovetail saddle locking knobs:** Compatible with Vixen/Losmandy style dovetail bars.



⑨ **Auto guide:** ST-4 compatible autoguiding port.

⑩ **USB:** USB-B 2.0 port: can be used to control the AM3 and upgrade the firmware. You can also connect USB devices such as the ASI AIR and PCs.

⑪ **BT:** You can connect the AM3 via Bluetooth on your smartphone "ASI Mount" App. The Bluetooth button will be useful for you to confirm whether the mount is connected. The Bluetooth indicator will keep the blue light on until you succeed in connecting the AM3 via Bluetooth.

⑫ **HC:** Can be used to connect the hand controller. The hand controller has a Wi-Fi adapter. Keep the hand controller connected if you want to connect the AM3 via Wi-Fi.

⑬ **DC 12V5A:** 12V DC power jack for D5.5×2.1mm, center positive. The power voltage should not be less than 10.8V. Otherwise, the buzzer inside the AM3 will beep to alert the user of low voltage.

⑭ **Status:** It is an operation mode indicator light. Red light for the equatorial mode, green light for the alt-azimuth mode. It will flash red and green when the time and location information is not synchronized to the AM3. Once synchronized, it will keep the light on in the mode's color accordingly.



⑮ **Latitude scale:** Indicates the current latitude of the AM3 from 0° to 90°.

⑯ **Dovetail saddle plate:** Compatible with Vixen/Losmandy style dovetail bars.

3.2 Introduction to the hand controller



① **Light Indicator:** Indicates the High or Low Slew Rate of the AM3. High Rate: when the red light is on.

② **Stick:** Can be used to control both axes to move accordingly. Press down the stick to switch between high and low slew speeds. There are 1X, 2X, 4X, and 8X of the Sidereal at low speed and 20X to 1440X of the Sidereal at high speed.

③ **T button:** Click to turn tracking on or off. When the tracking is on, the T button will turn the red light on, and the status indicator of the AM3 will flash red (green) in the equatorial (alt-azimuth) mode.

④ **Cancel button:** Can be used for canceling slew, going to the Home Position, and mode switching.

Canceling slew: Press the Cancel button when the AM3 is slewing or going to the Home Position to stop the current motion.

Going to the Home Position: Press and hold for 3 seconds. The AM3 will start going to the Home Position.

Mode switching: When the AM3 is powered off, press and hold the Cancel button and then turn on the AM3. Hold the Cancel button until the status indicator changes from one color to another. Then the mount is successfully switched to another mode.

Tips:

The hand controller has a Wi-Fi adapter. Keep the hand controller connected if you want to connect the AM3 via Wi-Fi. The default SSID and passcode are attached to the backside of the hand controller.



3.3 Mounting the AM3

3.3.1 Mount installation

*Tripod model: ZWO carbon fiber TC40 (optional)

Unfold the tripod



Install the silver mounting plate:

Fix the silver mounting plate onto the base of the AM3 with three M6 screws.



Install the AM3 onto the tripod:

Place the AM3 on the tripod, install the 3/8" rod in the correct direction (as shown in the first figure below). Then place the spreader plate to push up the tripod legs.

Then rotate the locking knob clockwise to fix it.



3.3.2 Hand controller connection

Connect the hand controller cable to the HC interface on the mount's front panel. There is a Wi-Fi adapter integrated in the hand controller, so you can wirelessly connect to the hand controller and then control the mount.



3.3.3 "ASI Mount" App installation

Scan the QR code below to download and install the ASI Mount App:



3.3.4 Optional accessory installation

3.3.4.1 Pier extension installation (optional)

First, place the pier extension onto the tripod and tighten the locking knob.



Second, place the AM3 (with the silver mounting plate installed) onto the pier extension and tighten the locking knobs on the pier extension.



Installation completes.



3.3.4.2 Counterweight installation (optional)

In which case should I use the Counterweight?

If the total weight of the telescope is less than 8 KG (17.6 lb), the AM3 does not need any counterweights. While if the total weight of the telescope reaches 8 KG (17.6 lb) or more, we recommend a 5 KG (11 lb) counterweight installed. But please keep in mind that the total weight of the telescope should not exceed 13 KG (28.6 lb). The coarse thread of the counterweight shaft's mounting house is M12×1.75.

Four steps to install counterweights:

1. Unscrew the counterweight shaft safety lock from the back panel of the mount.
2. Screw in the ZWO counterweight shaft (optional).
3. Attach the counterweight.
4. Screw the little safety lock onto the ZWO counterweight shaft.



3.3.4.3 The ASI AIR installation (optional)

Fix the ZWO finder shoe to the mounting holes on the side of the dovetail saddle plate. The ASI AIR can be installed here. Or if your telescope has a similar finder shoe, you can also install the ASI AIR there.



3.4 Use of the AM3

3.4.1 How to adjust the latitude angle?

There are two gears of the latitude angle,

Gear 1: 0° to 60°;

Gear 2: 30° to 90°.



To adjust the latitude angle from 0° to 90°, the steps are as follows:

*We recommend you do this when the AM3 is not carrying anything.

Loosen the tension grips on both sides and rotate the latitude fine adjustment knob clockwise till you can see the hex screws on AM3's two sides with no obstruction (approximately 45° latitude at gear 1).



Use the M6 Allen key to loosen the two hex screws anti-clockwise. Make sure they are loosened before you move into the next step.



Pull up the AM3 dovetail saddle plate, you will notice the two hex screws sliding to the other end of the slideway. While the latitude angle is about at 75° , re-tighten the hex screws on both sides.



Gear 2 gives an adjusting range of the latitude angle from 45° to 90° . Keep rotating the latitude fine adjustment knob clockwise will get the AM3 at a 90° latitude angle.



To adjust the latitude angle from 90° to 0°, take the above steps in reverse.

3.4.2 How to adjust the azimuth scale?

Rotate the Azimuth fine adjust knobs in opposite directions to each other to adjust the azimuth scale of the AM3. It is best to keep the knobs slightly done up to prevent wobble.



3.4.3 How to switch the equatorial /alt-azimuth mode?

The light indicator shows red for equatorial mode and green for alt-azimuth mode. After the mount boots, the light indicator will remain the color of the current mode for 5 seconds, then flash red and green in turn. At this time, you'll need to connect the mount to ASI AIR or any other astrophotography software in your laptop to sync the local time and coordinate information. Otherwise, the mount will not be able to GOTO nor track targets. After synchronization, the indicator light will return to the corresponding light.

Before switching the mode, turn off the AM3. We recommend you do this when the AM3 is not carrying anything.

Switch from the equatorial mode to alt-azimuth mode:

Connect the hand controller.

Press and hold the cancel button and then turn on the AM3.

You can release the cancel button when the status indicator light turns green from red.

Adjust the latitude angle of the AM3 to 90°(refer to 3.4.1).

The AM3 is now in the alt-azimuth mode.

Switch from the alt-azimuth mode to the equatorial mode

Connect the hand controller.

Press and hold the cancel button and then turn on the AM3.

You can release the cancel button when the status indicator light turns red from green.

Adjust the latitude angle of the AM3 to your latitude (refer to 3.4.1).

The AM3 is now in equatorial mode.

Note:

When installing the telescope in the alt-azimuth mode, please make sure the telescope is facing the correct direction, as shown in the figure below (when the AM3 is in the Home Position, the dovetail saddle locking knobs are facing upwards). If the telescope is installed in the opposite direction, it will cause GOTO and tracking errors.

Correct installation way:



Wrong installation way:



3.4.4 How to control the AM3 on PC?

Preparation: Power on the AM3 and use the ZWO USB-B to USB-A 2.0 cable to connect the USB port on the AM3 and the USB-A port on your PC.

Step 1: Go to the ZWO official website: <https://www.zwoastro.com/downloads> and select [Download].

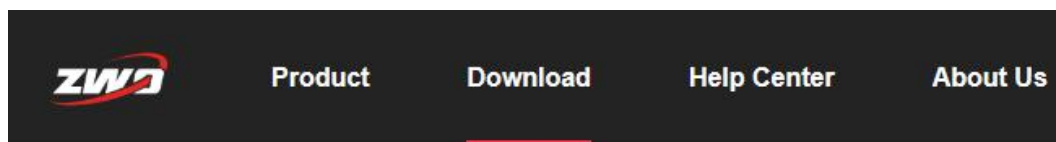

Home > Help Center > Download

Step 2: Click to download the ASCOM Platform and the ASCOM driver.

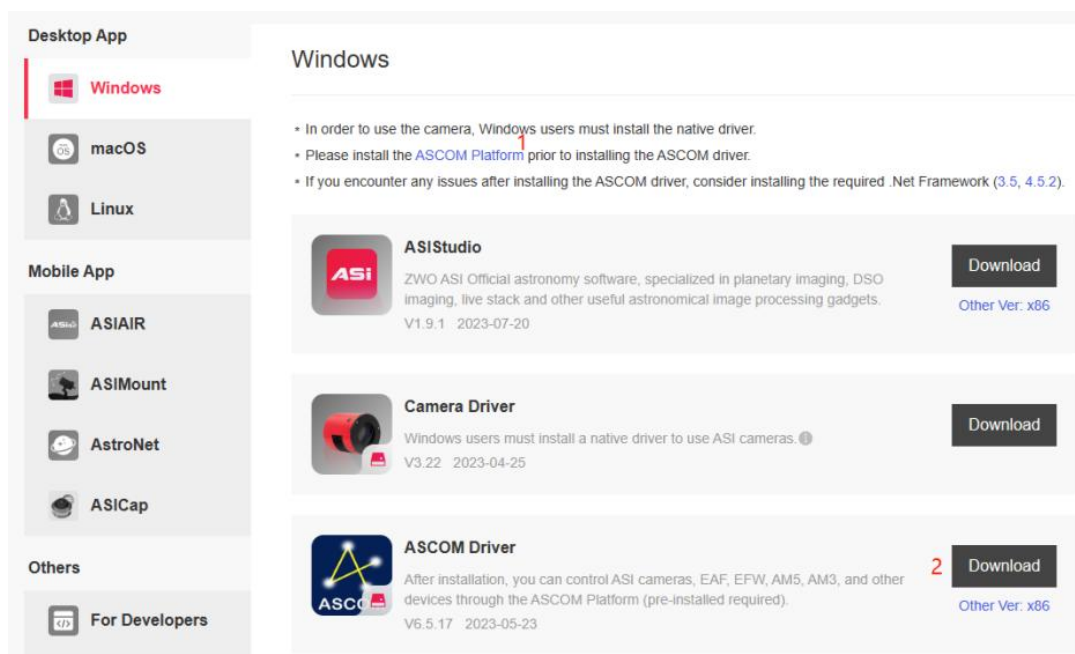

Step 3: Double-click to install the ASCOM Platform and the ASCOM driver.

Step 4: Install the application software that supports the ASCOM driver, such as ASISudio, MaxIm DL, NINA and SGP. Here we choose NINA as an example.

Step 5: Open NINA and 1. Click "Equipment"; 2. Click "Telescope"; 3. Select "ASI Mount"; 4. Click the "Connect" button.

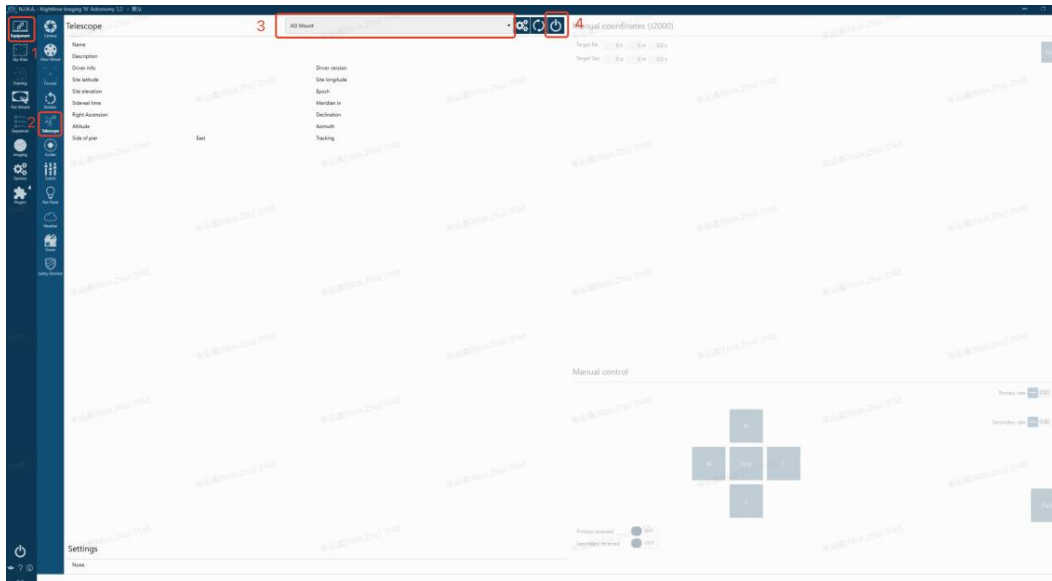

Step 6: Now, you can control the AM3 via NINA.

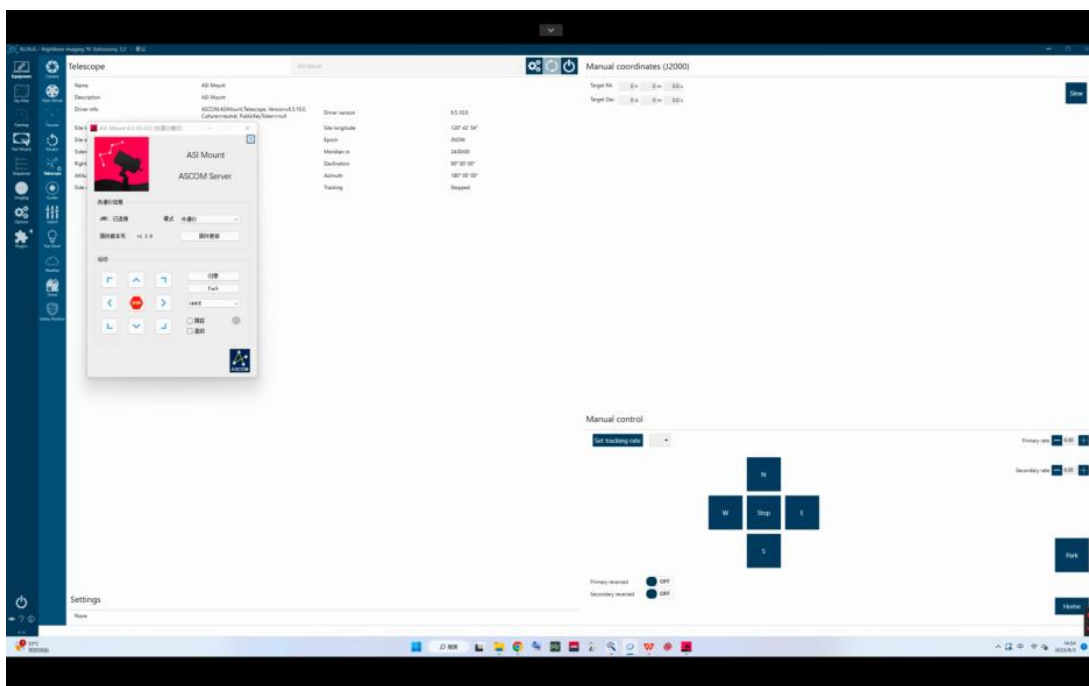

3.4.5 How to control the AM3 via Bluetooth

The AM3 has a Bluetooth module onboard. You can control the AM3 via Bluetooth if you forget to take the hand controller.

Step 1: Install the "ASI Mount" App on your smartphone.

Scan the QR code with your smartphone as shown below to download and install the "ASI Mount" App:



Step 2: When the AM3 is powered on, please check the BT indicator to see if it shows the blue light. If not, please press and hold the BT button for 5 seconds to reboot the Bluetooth module.

Step 3: Open the "ASI Mount" App on your smartphone. First, tap the "Mount" icon (as marked 1 in the screenshot below) and then choose "Bluetooth" (as marked 2 in the screenshot below).

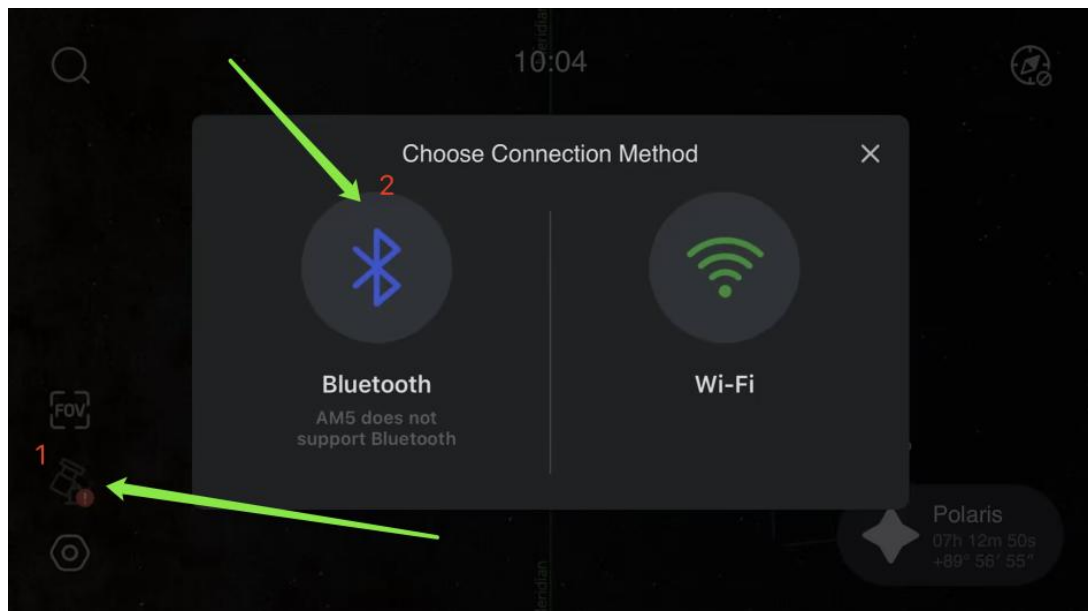

Step 4: The App will show a list of the AM3s for connection. Choose your AM3, and the BT indicator on your AM3 will flash in blue, which means your smartphone communicates with your AM3 correctly. Click the BT button once to confirm the connection.



Step 5: Now, you can control the AM3 via Bluetooth.

3.4.6 How to control the AM3 via ASI AIR?

Step 1: Install the "ASI AIR" App on your smartphone.

Scan the QR code with your smartphone, as shown below, to download and install the "ASI AIR" App.



Step 2: You can install your ASI AIR on the AM3 dovetail saddle plate (as shown below) or on the finder bracket of your telescope. Use the ZWO USB-B to USB-A 2.0 cable to connect the USB port on the AM3 and the USB-A port on your ASI AIR.



Step 3: Power on your ASI AIR and AM3. When the system of the ASI AIR is ready, select the corresponding ASI AIR wireless signal in the wireless LAN of your smartphone.

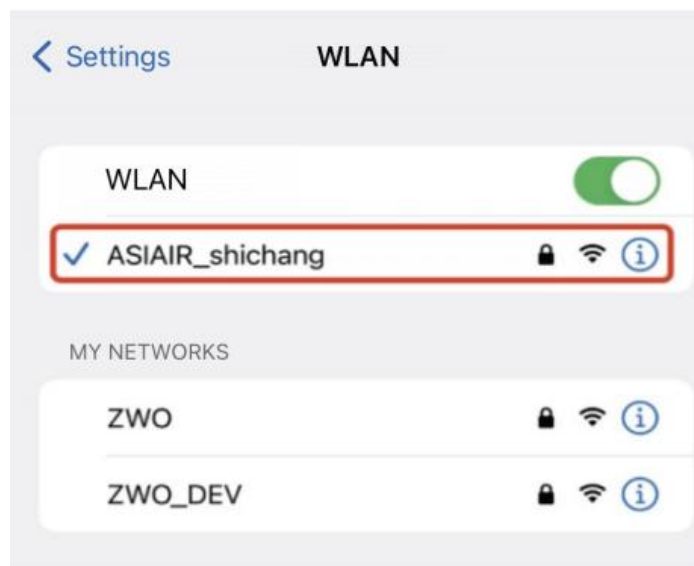

Step 4: Open your smartphone's "ASI AIR" App and go to the mount selection page. Select "ZWO AM5" and then click the button to establish the connection. The serial port will show that it is connected, and the parameters of your AM3 will be displayed on this page.

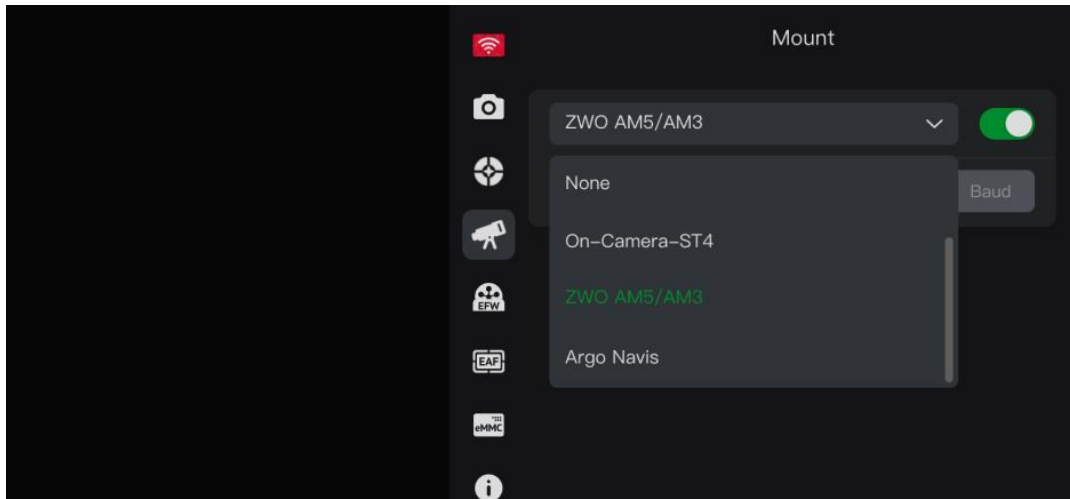

Return to the App's main page, and you can control your AM3 via the stick in the "ASI AIR" App.

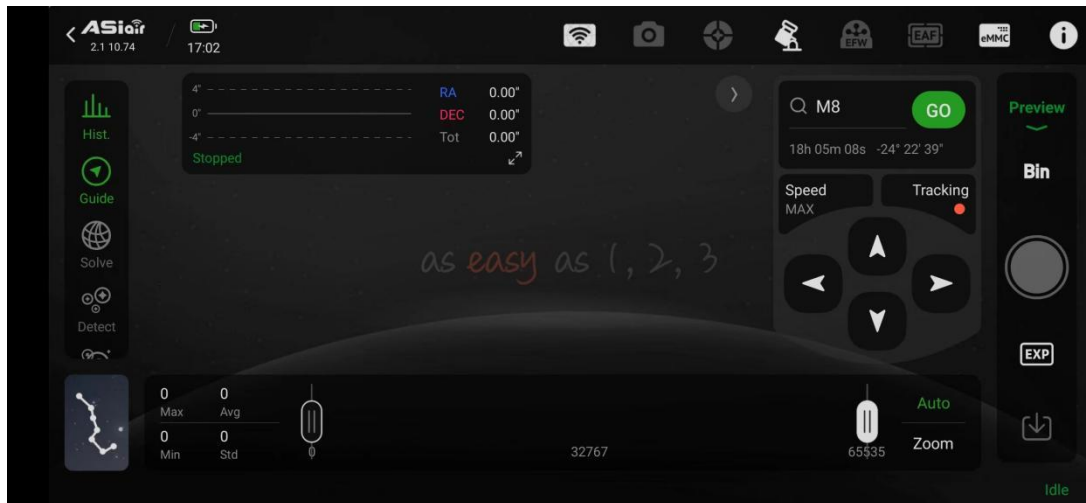

4. Structural Dimensions

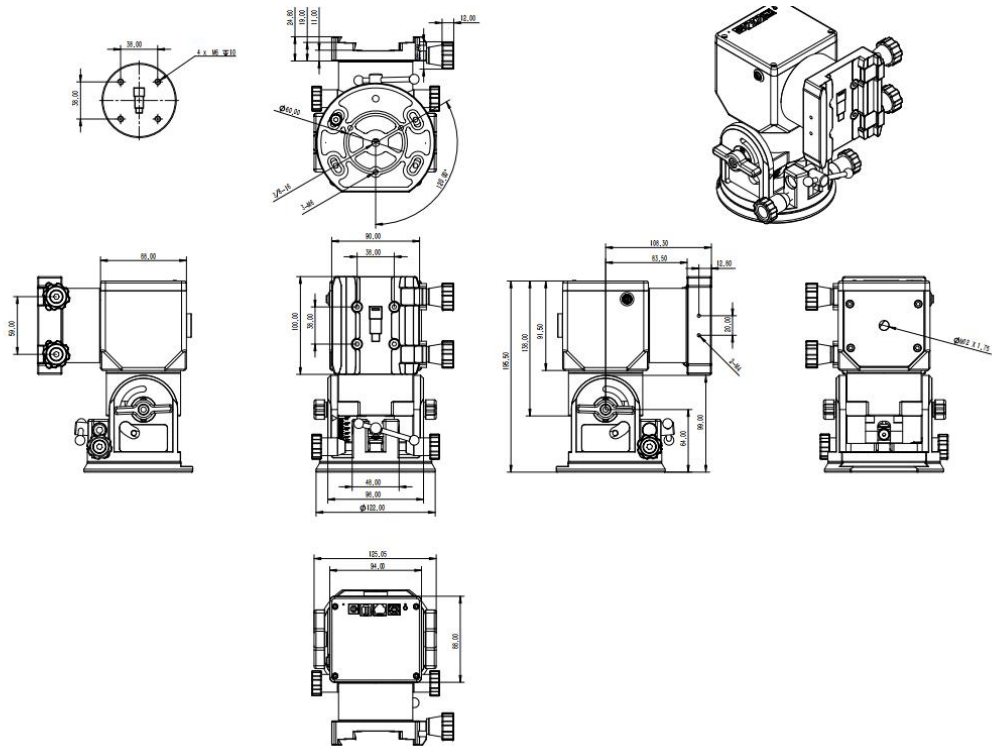

5. After sales

For software upgrades, please download the update directly from the official website, " Official Website Homepage - Technical Support - Software. "

<https://www.zwoastro.com>

For repairs and other services, please get in touch with us:

Email address: support@zwoptical.com

1. For products usually repaired or replaced within the warranty period, the user will bear the cost of returning them. When sending back the product, the user should note the real cause of the product damage and provide corresponding valid proof, such as pictures or videos. For products that need to be replaced after being confirmed by ZWO in writing, the user should return the fully packaged product with all accessories, manuals, etc., to the address designated by ZWO.

By sending back the product, the user agrees to pay the maintenance fee that may be incurred during the product maintenance process, which is not covered by the warranty service. ZWO will return the product after payment.

2. For products that need to be sent back for after-sales service, ZWO will provide the corresponding RMA code for reference. ZWO will only accept returned products with an RMA number and ZWO's written confirmation.

3. If the user purchased the ZWO product from a ZWO agent, he can directly contact the ZWO agent to obtain relevant after-sales service.

6. Warranty

1. ZWO provides a 2-year free warranty service for the products purchased by users from the company, and the warranty period starts from the day after the user receives the product; for AM3 equatorial mount products, the warranty period starts from the activation date of the user's equipment.

2. If the user encounters the following damage-on-arrival (DOA) situations and contacts ZWO within the corresponding period, and issues product purchase invoices and relevant certificates, ZWO will provide free postage service and offer the following products after-sales replacement (or partial replacement), repair or return (or partial return) service:

1) Product quality problem: If you find a quality problem with the product within 180 days from receipt, you can contact ZWO to confirm it has quality problems or defects after testing by the ZWO customer service center. You can get a free replacement service.

2) Product transportation problem: After receiving the product, the user finds that the outer packaging of the product has obvious signs of water soaking or serious backlog and deformation, and shall provide ZWO with pictures of the outer packaging of the product and receipt of the goods within three days from the date of receipt of the product. After verification by the ZWO customer service center, it is confirmed that the product is directly shipped to the user or agent by ZWO, then ZWO will provide relevant return and exchange services; if the product is directly sold or shipped to the user by the ZWO agent, the ZWO agent will be responsible for providing relevant return and exchange services.

3. If the product occurs in the following situations, it is not within the scope of warranty service, and ZWO can provide maintenance services for users:

1) The product exceeds the warranty period;

2) The product is exposed to liquid and corroded by moisture;

3) The product is damaged by external force (such as scratches on the surface, deformation of the product shell, broken USB port, etc.);

4) Dismantling, third-party maintenance, modification and refurbishment, flashing (downloading wrong firmware) without express written authorization from ZWO;

5) The product system is changed, or the warranty label is lost or changed;

6) Product quality problems caused by failure to install according to product usage requirements or instructions;

7) Physical damage and failure of the product caused by irresistible external forces (such as floods, fires, earthquakes, lightning strikes, and other strong vibrations or extrusions);

8) Damage caused by improper user operation during shooting or use;

9) There is no valid product purchase invoice or warranty certificate;

10) The product purchased by the customer is a second-hand product.

Quality problems with accessories or other product parts are not a condition for returning the host, and users can request a replacement of new accessories separately.

